

Packing Quantity

Package	Tape Width (mm)	Reel Size (inch)	Reel Quantity	BOX Quantity	Carton Quantity
SOT-23-3L	8	7	3000	30000	120000

Note 1: These are minimum package quantities only. Minimum orders will differ. Contact the factory for more information on minimum order quantities.

Note 2: GOFORD Tape&reel products meets EIA-481 REV D specification.

Device Tape orientation Start and Finish Specification

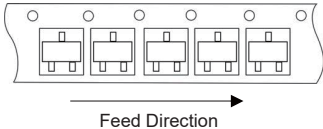
Package	Tape Width (mm)	Tape Orientation	Empty components at start (pockets)--close to the reel center	Empty components at finish (pockets)--close to the reel outside
SOT-23-3L	8		100	50

Embossed carrier Tape specifications

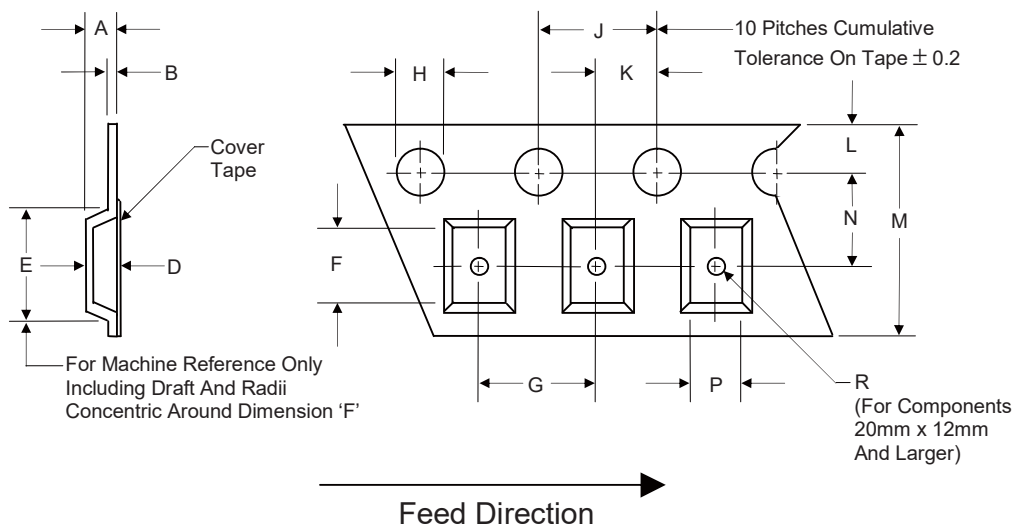

Tape Width	H	L	J	B	D	F	P
8mm	1.5	1.75	4.0	0.2	/	3.25	3.25
(Tolerance)	+0.1	±0.1	±0.1	±0.02	/	±0.1	±0.1
Tape Width	E	R	N	A	K	M	G
8mm	/	1.0	3.5	1.35	/	8.0	4.0
(Tolerance)	/	+0.1	±0.1	MIN	/	±0.1	±0.1

Surface Mount Reel Specifications

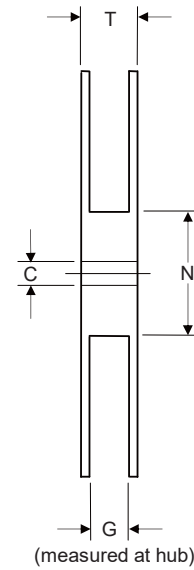
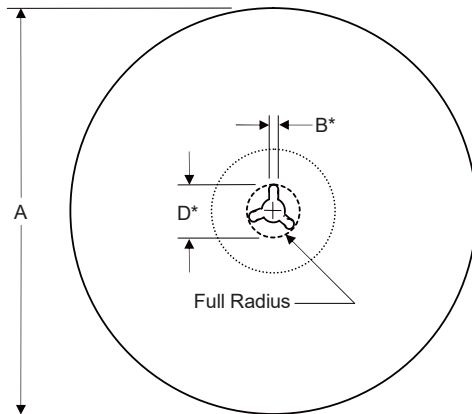

* Drive spoke dimensions optional. If drive spoke is used then asterisked dimensions apply.

Tape Width	A	B	C	D	N	G	T
8mm	178	3.0	13.3	20	54	9.2	11.6
(Tolerance)	±1.0	±0.1	±0.3	±0.2	±0.5	±1.2	±1.6

Dimensions

Inbox size

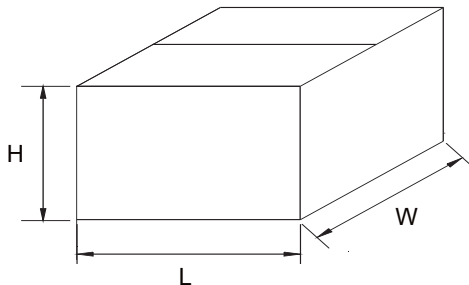

Dimension	Specification(mm typical)
	General
L	210
W	210
H	210

Carton size Feed Direction

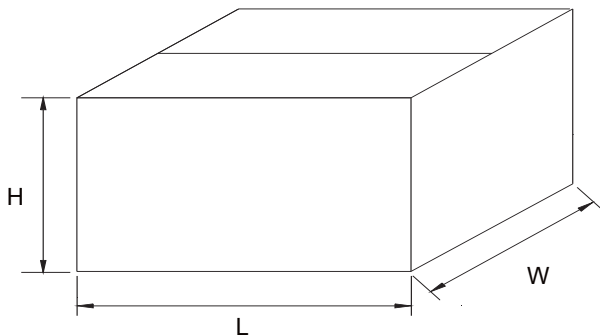

Dimension	Specification(mm typical)
	General
L	440
W	440
H	230

Packing Quantity

Package	Tape Width (mm)	Reel Size (inch)	Reel Quantity	BOX Quantity	Carton Quantity
SOT-23-3L	8	7	3000	30000	120000

Note 1: These are minimum package quantities only. Minimum orders will differ. Contact the factory for more information on minimum order quantities.

Note 2: GOFORD Tape&reel products meets EIA-481 REV D specification.

Device Tape orientation Start and Finish Specification

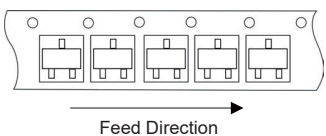
Package	Tape Width (mm)	Tape Orientation	Empty components at start (pockets)--close to the reel center	Empty components at finish (pockets)--close to the reel outside
SOT-23-3L	8		50	100

Embossed carrier Tape specifications

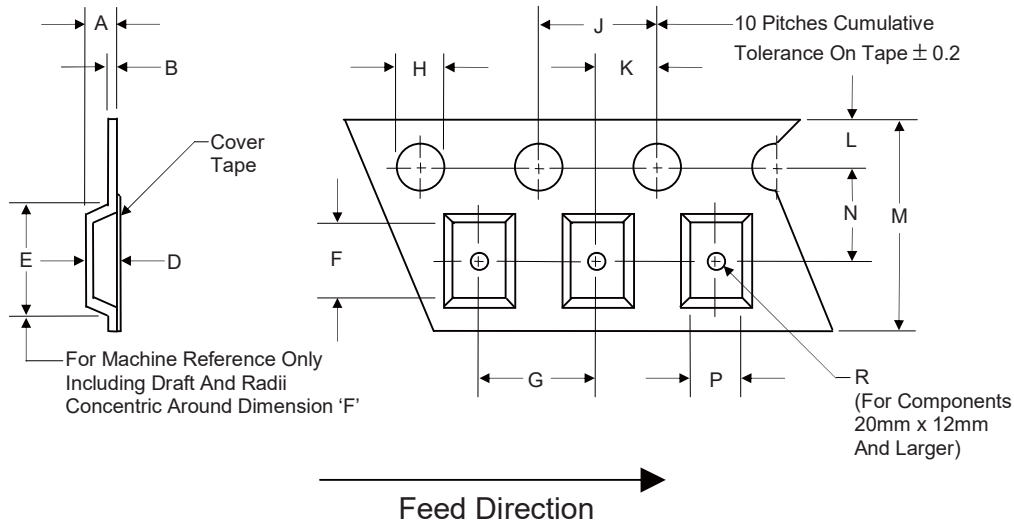

Tape Width	H	L	J	B	D	F	P
8mm	1.55	1.75	4.0	0.25	/	3.28	3.2
(Tolerance)	±0.05	±0.1	±0.1	±0.02	/	±0.1	±0.1
Tape Width	E	R	N	A	K	M	G
8mm	3.78	1.1	3.5	1.32	2.0	8.0	4.0
(Tolerance)	MIN	±0.1	±0.1	MIN	±0.05	±0.3	±0.1

Surface Mount Reel Specifications

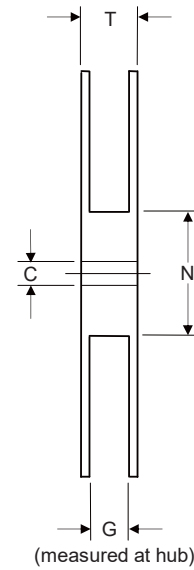
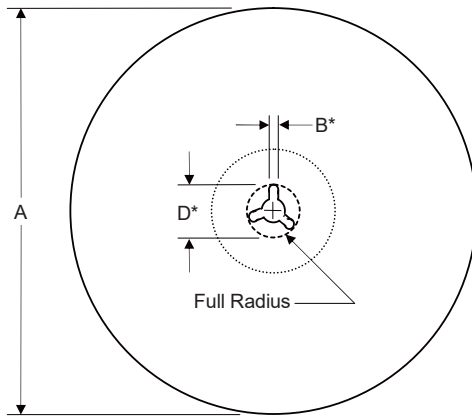

* Drive spoke dimensions optional. If drive spoke is used then asterisked dimensions apply.

Tape Width	A	B	C	D	N	G	T
8mm	178	/	13.0	25.6	54.4	9.5	12.3
(Tolerance)	/	/	/	/	/	/	/

Dimensions

Inbox size

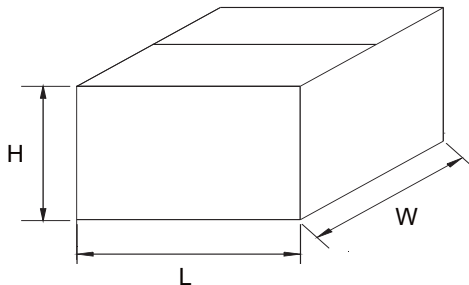

Dimension	Specification(mm typical)
	General
L	210
W	205
H	205

Carton size Feed Direction

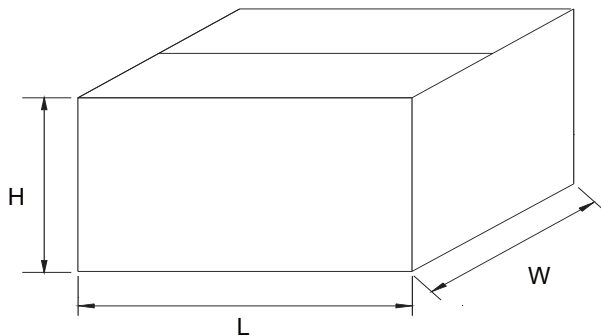

Dimension	Specification(mm typical)
	General
L	430
W	430
H	230

Packing Quantity

Package	Tape Width (mm)	Reel Size (inch)	Reel Quantity	BOX Quantity	Carton Quantity
SOT-23-3L	8	7	3000	30000	120000

Note 1: These are minimum package quantities only. Minimum orders will differ. Contact the factory for more information on minimum order quantities.

Note 2: GOFORD Tape&reel products meets EIA-481 REV D specification.

Device Tape orientation Start and Finish Specification

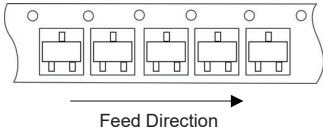
Package	Tape Width (mm)	Tape Orientation	Empty components at start (pockets)--close to the reel center	Empty components at finish (pockets)--close to the reel outside
SOT-23-3L	8		30	140

Embossed carrier Tape specifications

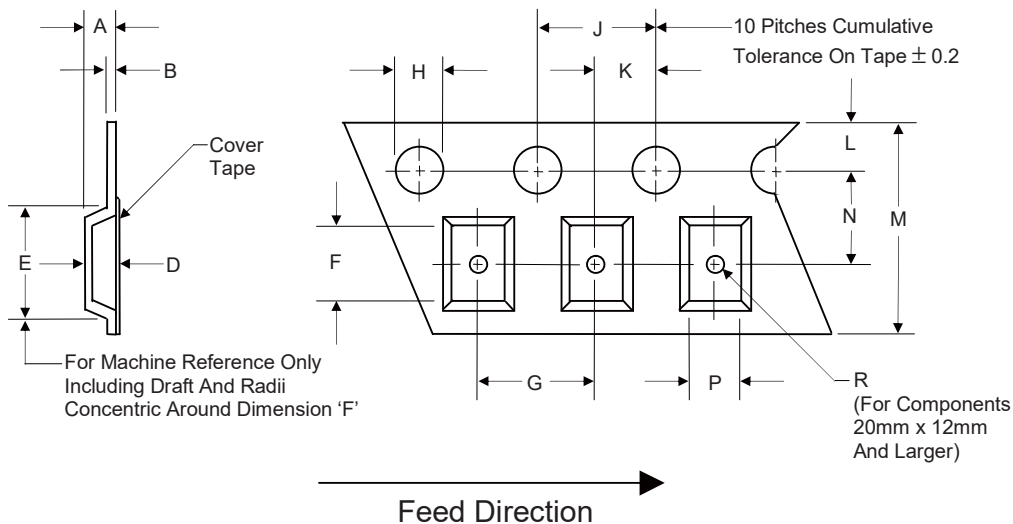

Tape Width	H	L	J	B	D	F	P
8mm	1.5	1.75	4.0	0.2	/	3.3	3.26
(Tolerance)	+0.1	±0.1	±0.1	±0.02	/	±0.1	±0.1
Tape Width	E	R	N	A	K	M	G
8mm	3.7	1.05	3.5	1.35	2.0	8.0	4.0
(Tolerance)	MIN	±0.05	±0.05	MIN	±0.05	±0.1	±0.1

Surface Mount Reel Specifications

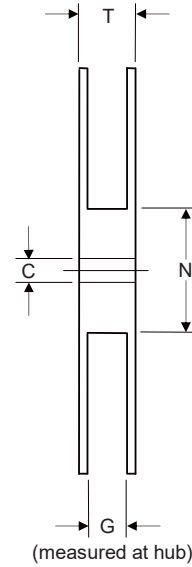
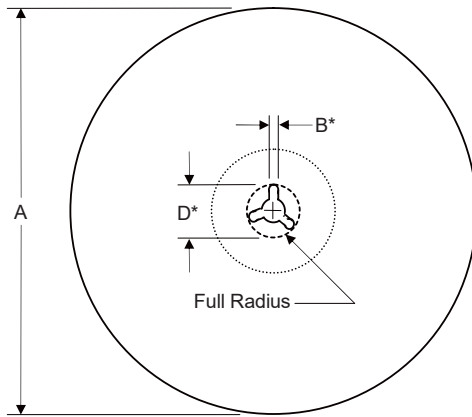

* Drive spoke dimensions optional. If drive spoke is used then asterisked dimensions apply.

Tape Width	A	B	C	D	N	G	T
8mm	180	2.0	13.0	20.2	54.4	8.6	12.4
(Tolerance)	±0.1	+0.5	+0.5/-0.2	MIN	+1.0	+1.0	MAX

Dimensions

Inbox size

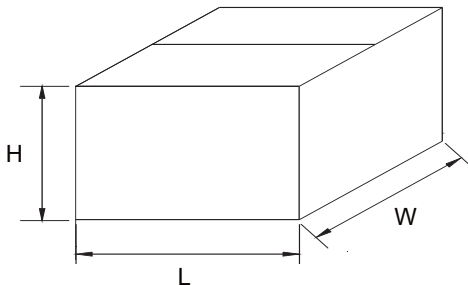

Dimension	Specification(mm typical)
	General
L	210
W	210
H	210

Carton size Feed Direction

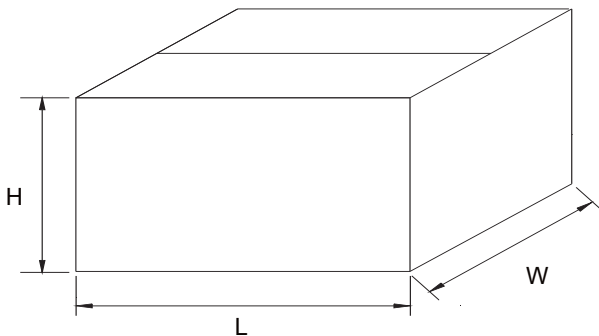

Dimension	Specification(mm typical)
	General
L	445
W	445
H	230